

Ceiling Pockets for MechoShades® and ElectroShades®

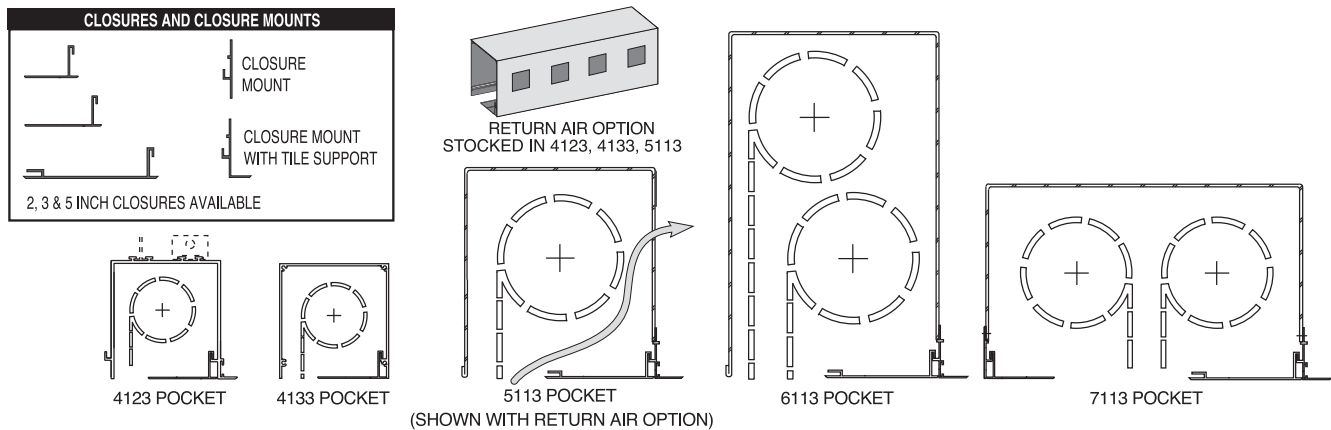

Ceiling Pockets

MechoShade Systems, Inc. offers a complete line of pockets and pocket accessories, which allow MechoShades® and ElectroShades® to be integrated into the ceiling for concealment of shades above the ceiling. Pockets are available in single or double shade systems utilizing the least amount of space possible. Pocket accessories include a wide range of removable closure angles that allow for visual concealment of the rollers and minimize the reveal that the shade's hem bar passes through, providing clean lines and details and a tile support to support the ceiling grid.



MechoShade's prefabricated pocket designs include two models in white extruded aluminum. The 4123 pocket features an integrated tile support as well as a hanging raceway, which, along with a variety of clips, provides a large array of mounting/installation options. The 4133 pocket can be recessed, surface mounted or, when the optional end-caps are used, like a cassette. Other models such as the 5113, 6113 and 7113 pockets are supplied in bent, 16 gauge steel, with a PaintLoc® finish and white painted extruded aluminum trim pieces. Bent metal pockets are stocked in 10' lengths. Extruded aluminum pockets are stocked in 15 foot lengths.

Custom Pocket Designs:

Custom designed bent metal or extruded aluminum pockets with accessories are available for your project. Size and quantity will dictate whether a custom pocket design will be extruded aluminum or bent steel. Contact your MechoShade Representative with details of your project's requirements.

Pocket Accessories:

MechoShade has a large variety extruded aluminum closure mounts and angles of varying types and sizes. These accessories can be utilized with drywall, wood or bent metal pockets by others, while providing the same removable closure/slot assembly found in our complete pocket assemblies.

Return Air Option for Pockets:

All MechoShade pockets can be vented by punching a series of 2" (51 mm) square holes. This procedure helps to reduce thermal stress on the glass as well as solar heat build-up at the window wall. It also increases air circulation by providing greater air movement through the return plenum. If custom spacing is required by your consulting engineers, please contact your MechoShade representative for pricing and fabrication requirements.

"No Cost Pocket"

MechoShade's "No Cost Pocket" design provides the ability to conceal the shades above the ceiling inexpensively and have the same return air capabilities as the return air pocket. By use of wall angles MechoShade or ElectroShade brackets can be integrated to the ceiling grid, or one can simply stop the ceiling several inches from the window wall. MechoShade's aluminum closure mounts and closure angles can be integrated to provide the same removable trim pieces as the standard pocket.

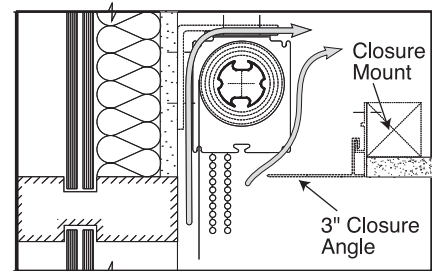

The "No-Cost" Pocket design can be an especially important cost savings in base building design where large quantities may be required.

Pre-Construction Services:

MechoShade staff can provide detailed sketches and drawings of suggested installation details, to conform to your projects requirements. Please contact your MechoShade representative with your project information. MechoShade recommends that an engineer review any proposed details where thermal stress on glass is being evaluated or customer service representative.

MechoShade Systems, Inc.
42-03 35th Street, Long Island City, NY 11101
Telephone: 718-729-2020
Fax: 718-729-2941 / 800-899-8081

E-mail: info@mechoshade.com
Internet Web Site: www.mechoshade.com

6.01
MS2200-01/01/08



Pocket and Accessory Features and Specifications

- #4123 Recessed Pocket with Tile Support.** Extruded aluminum shade pocket, 5-15/16" W x 5-1/4" H x 15ft. L (135mm x 133mm x 457cm), in 6063T5 baked PPG enamel finish in standard white or standard custom colors by special order. Comes with exposed flush mounted tile support for acoustical tile or dry wall soffits and ceilings. An optional exposed flush mounted extruded aluminum removable closure panel is available to provide access to the shades. (See item 8.)
- #4133 Surfaced Mounted Pocket. No Tile Support.** Extruded aluminum shade pocket, 4-3/4" W x 5" H x 15ft. L (121mm x 127mm x 457cm), in 6063T5 baked PPG enamel finish in standard white or standard custom colors by special order. An optional exposed flush mounted extruded aluminum removable closure panel is available to provide access to the shades. (See item 8.)
- #5113 Recessed Pocket with Tile Support.** Steel shade pocket, 8-3/4" W x 9-1/2" H x 10ft. L (223mm x 241mm x 305cm), unpainted with white trim. Comes with exposed flush mounted tile support for acoustical tile or dry wall soffits and ceilings. An optional exposed flush mounted extruded aluminum removable closure panel is available to provide access to the shades. (See item 8.)
- #6113 Recessed Pocket with Tile Support.** Steel shade pocket, 9-1/4" W x 15" H x 10ft. L (235mm x 381mm x 305cm), unpainted with white trim. Comes with exposed flush mounted tile support for acoustical tile or dry wall soffits and ceilings. An optional exposed flush mounted extruded aluminum removable closure panel is available to provide access to the shades. (See item 8.)
- #7113 Recessed Pocket with Tile Support.** Steel shade pocket, 9-1/4" (235mm) W x 15" (381mm) H x 10ft. (305cm) L, unpainted with white trim. Comes with exposed flush mounted tile support for acoustical tile or dry wall soffits and ceilings. An optional exposed flush mounted extruded aluminum removable closure panel is available to provide access to the shades. (See item 8.)
- Custom Sized Bent Pockets.** Custom sized bent pockets up to 10 ft. long are available by special order. Call your MechoShade technical support representative for size limitations.
- Return Air Option Pockets.** Return Air Option is a series of ventilation holes, punched into the side wall of the pocket. This allows for heated return air to vent into the plenum. Return Air Pockets minimize the potential for thermal stress when shades are extended over the glazing. Especially for room darkening glazing systems. Venting the concentrated heat, between the shade and window, minimizes the heat entering the room and improves the efficiency of the HVAC. For Return Air Pockets add "AR" to the pocket number, i.e. 4123AR, 4133RA, etc. Standard return air openings: 12 square inches per linear foot (774.2mm² per liner meter). If different return air is required it must be specified.
- Closures.** Extruded aluminum pocket closure assembly in 6063T5 baked PPG enamel finish in standard white or standard custom colors by special order. Closure panel available in 2", 3" and 5" x 15ft. (50mm, 76mm and 127mm x 457cm. or custom width.
- Single Closure Mount and Closure Mount with Tile Support.** Extruded aluminum Single Closure Mount or Closure Mount with built in Tile Support in 6063T5 baked PPG enamel finish in standard white or standard custom colors by special order. Single Closure Mount 1-1/2" W x 2-5/6" H x 15ft. L (38mm x 59mm x 457cm). Closure Mount with Tile Support 3/8" W x 2-5/16" H x 15ft. (910mm x 59mm x 457cm).



Recessed Ceiling and Surface Mounted Pocket Details

#4123 RECESSED POCKET

(P/N: UPOC 4215 AL WH)

Ideal for Mecho®/5, Mecho®/5 Pocket Brackets, Electro®/3 Pocket Brackets and Electro®/1 Brackets.

Shown: Pocket w/ Optional Air Return

(P/N: UPOC 4215RAL WH)

(Closure sold separately.)

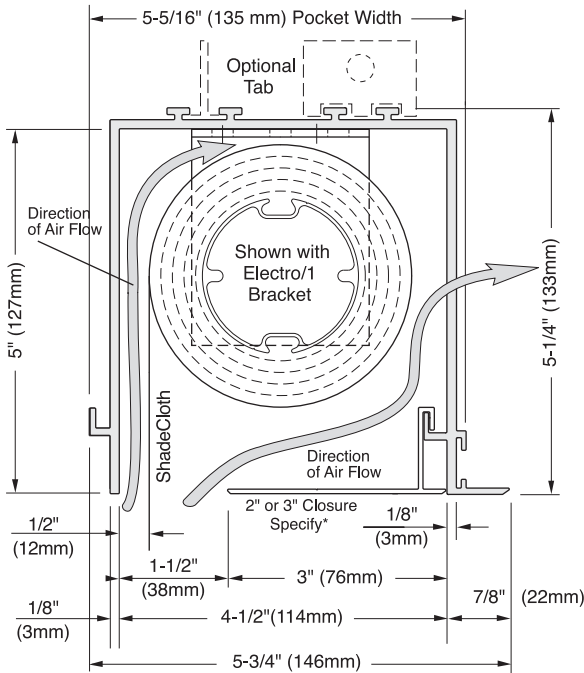

#4133 SURFACE MOUNTED POCKET

(P/N:UPOC 4315 AL WH)

Ideal for Mecho®/5, Mecho®/5 Pocket Brackets, Electro®/3 Pocket Brackets and Electro®/1 Brackets.

Shown: Pocket w/ Optional Air Return

(P/N: UPOC 4315RAL WH)

(Closure sold separately.)

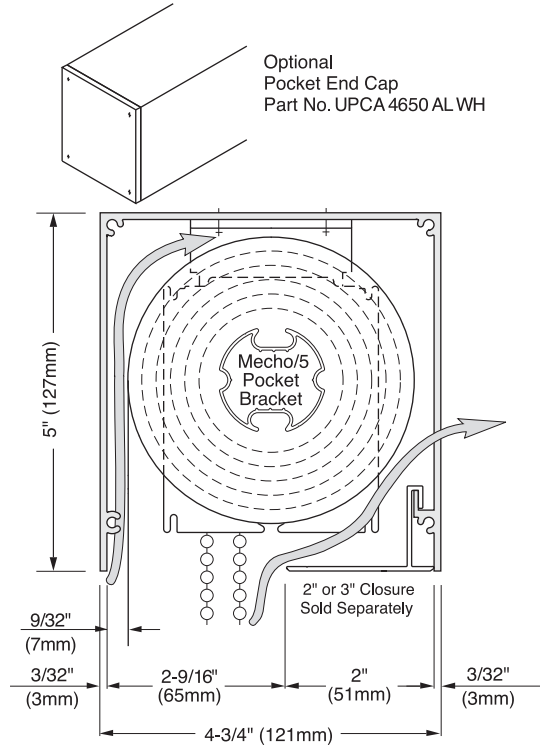

* MechoShade recommends a 2" Closure (P/N: UCLX 2015 AL WH) with a chaindrawn system and a 3" Closure (P/N: UCLX 3015 AL WH) with a motorized system.

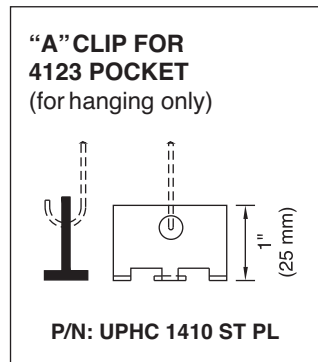

45- DEGREE MITER-CUT FOR #4123 POCKET ASSEMBLY

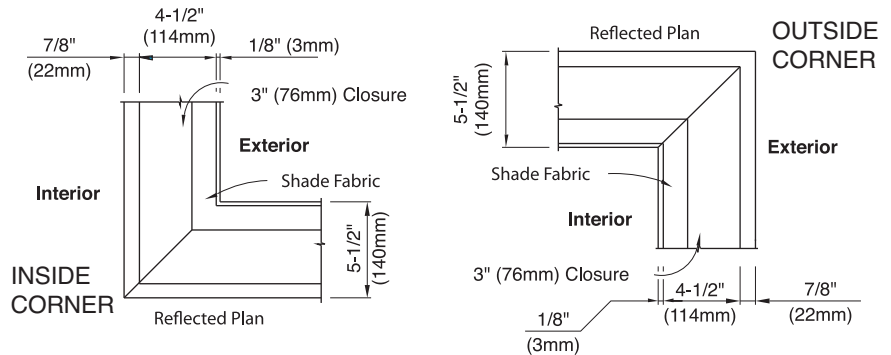

MechoShade Systems, Inc.
42-03 35th Street, Long Island City, NY 11101
Telephone: 718-729-2020
Fax: 718-729-2941 / 800-899-8081

E-mail: info@mechoshade.com
Internet Web Site: www.mechoshade.com

6.03
MS2200-01/01/08



Recessed Ceiling Pockets Details

#5113

RECESSED POCKET

(P/N: UPOC 5110 ST PL)

Shown: Pocket w/ Optional Air Return

(P/N: APTS 5113RST PL)

5" (127mm) Closure sold separately

(P/N: UCLX 5015 AL WH)

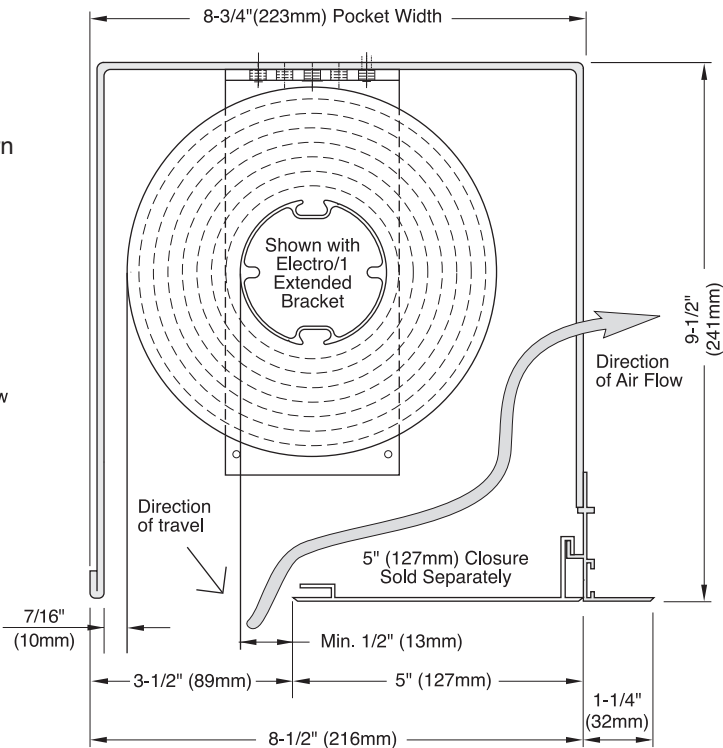
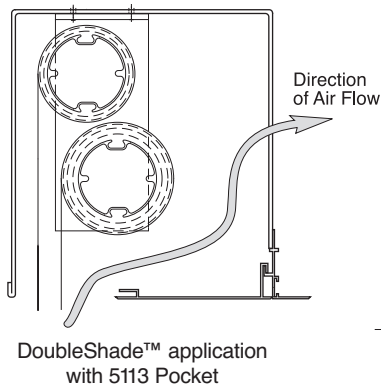

#7113

RECESSED POCKET

(P/N: UPOC 7110 ST PL)

3" (76mm) Closure sold separately.

(P/N: UCLX 3015 AL WH)

5" (127mm) Closure sold separately.

(P/N: UCLX 5015 AL WH)

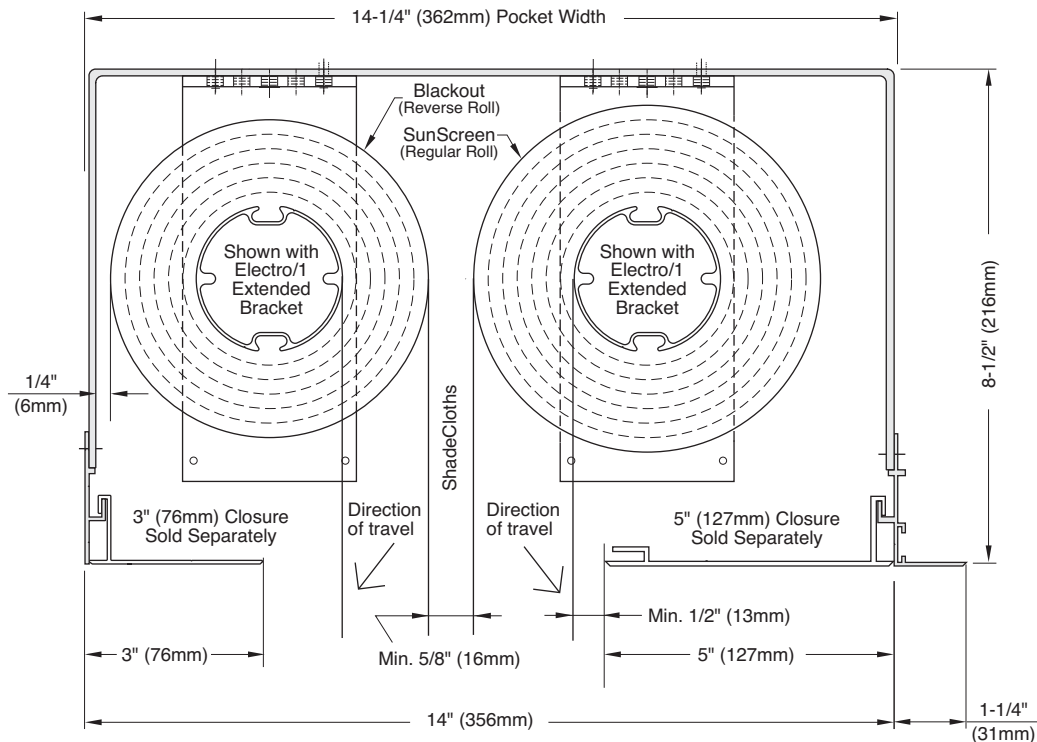

MechoShade Systems, Inc.
 42-03 35th Street, Long Island City, NY 11101
 Telephone: 718-729-2020
 Fax: 718-729-2941 / 800-899-8081

E-mail: info@mechoshade.com
 Internet Web Site: www.mechoshade.com

6.04
 MS2200-01/01/08



Recessed Ceiling Pocket Details

#6113 RECESSED POCKET

(P/N: UPOC 6110 ST PL)

5" (127mm) Closure
sold separately.

(P/N: UCLX 5015 AL WH)

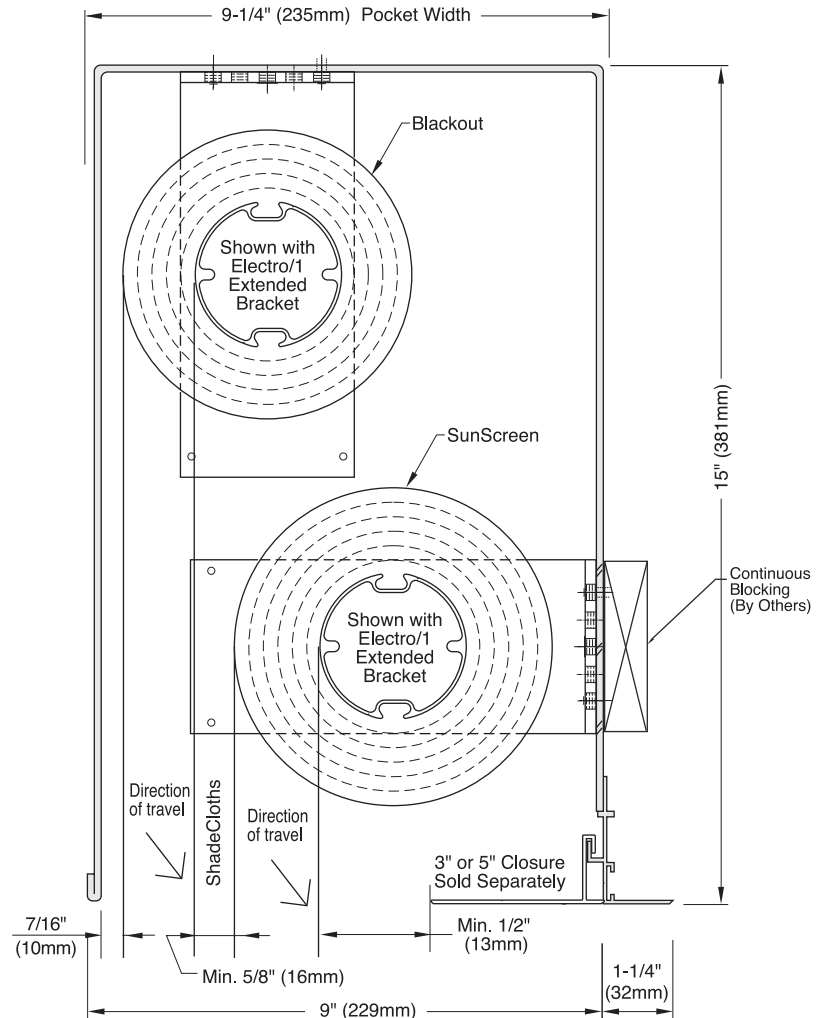
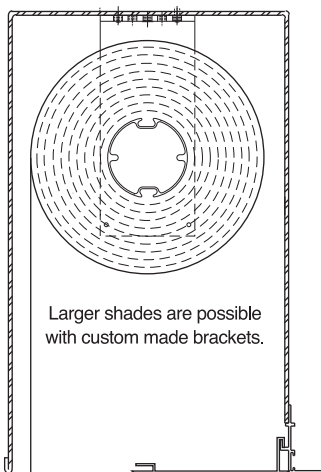

Optional Sound Stop

A 1" (25mm) fiberglass sound stop can be installed between shade brackets in a ceiling pocket to help reduce noise between work areas. Sound stops are available for the 4123, 4133, 5113, 6113 and 7113 pockets.

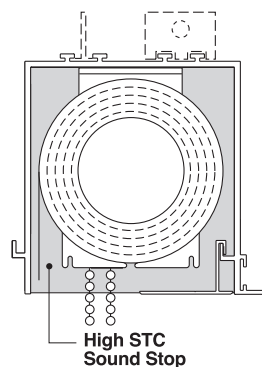

MechoShade Systems, Inc.
42-03 35th Street, Long Island City, NY 11101
Telephone: 718-729-2020
Fax: 718-729-2941 / 800-899-8081

E-mail: info@mechoshade.com
Internet Web Site: www.mechoshade.com

6.05
MS2200 - 01/01/08



Closures and Closure Mounts

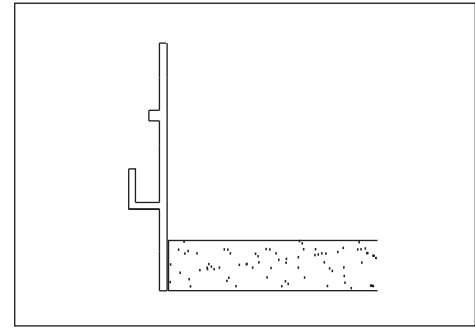
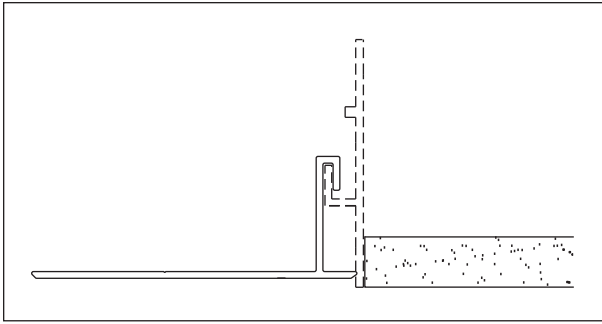

2" CLOSURE
(P/N: UCLX 2015 AL WH)

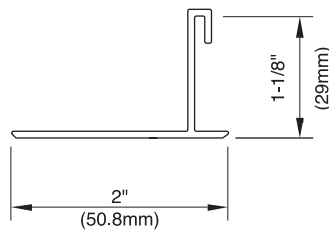

3" CLOSURE
(P/N: UCLX 3015 AL WH)

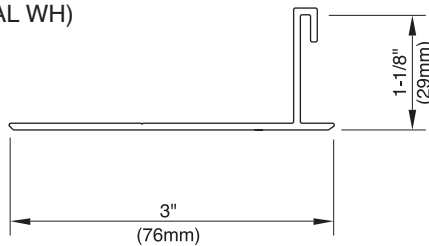

5" CLOSURE
(P/N: UCLX 5015 AL WH)

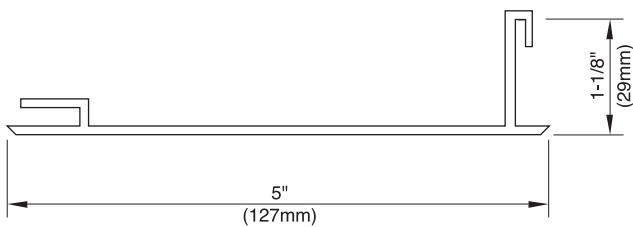

SINGLE CLOSURE MOUNT
(P/N: UCMX SG15 AL WH)

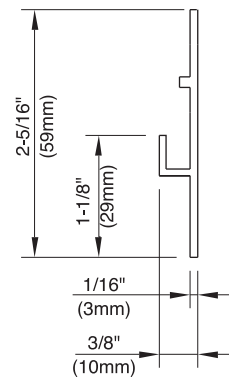

CLOSURE MOUNT WITH TILE SUPPORT
(P/N: UCMX TS15 AL WH)

