

MechoShade® Hardware Features and Specifications

MECHO®/5

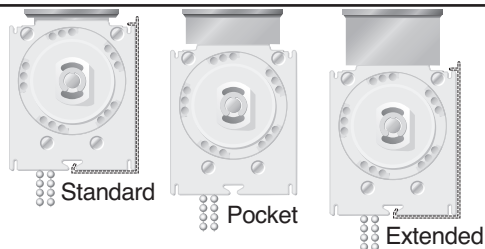

1. **Mounting Brackets**

The drive assembly, idle-end assembly, and center support systems are attached to an 1/8 in. (3mm) steel universal mounting bracket.

2. **No Adjustment Necessary**

Mecho®/5 drive-end bracket requires no adjustment, resulting in faster installations.

3. **Braking**

An overrunning clutch design that disengages to 90% during the raising and lowering of the shade and can withstand a pull force of 40 lbs. (18 kg). Recommended maximum lift shade-band 20 lbs. (9 kg).

4. **Braking Surface:**

The patented self-lubricating oil impregnated steel hub, on which the brake system is mounted, includes an articulated brake assembly which assures smooth, non-jerky operation in raising and lowering the shades.

5. **Sprocket**

A one-piece molded Delrin® chain sprocket.

6. **Hardware**

All hardware is available with a universal offset drive and left-hand or right-hand operations. The offset-drive chain assembly places both operating chains at the same location or to the rear of the shade cloth out of sight. The distance between the center line of the operating chain shall not exceed 1/2 in (13mm).

7. **Tube Support**

A Delrin® cover plate provides protection from the tube being dislocated. In the event the tube should be pushed out of place, the Delrin end of the mounting

plates contains the tube which may prevent the tube from falling out of the bracket.

8. **Wide Spans**

Depending on the height, weight and shade cloth specified, MechoShades can be made up to 12 feet wide or more. Call your local representative or MechoShade Systems technical support.

9. **Interchange or replacement**

Bracket components can be interchanged or replaced without having to remove the brackets from the walls or ceilings. This feature is included in both inside and outside mountings.

10. **Component Quality**

Plastic components are made of strong, dimensionally stable DuPont Delrin™. Not ABS/polystyrene or nylon.

11. **Bracket Metal**

Support brackets are plated 1/8 in. (3mm) steel. Custom colors are available on special order.

12. **Narrow-Edge Clearances**

Drive-end: 13/16 in. (21mm), idle-end: 1/2 in. (13mm), and center support: 5/16 in. (8mm).

13. **Multi-Band Shade**

A single drive bracket can handle two or more shade bands permitting a single operator to operate the shade, assuring simultaneous alignment of all the bands (within MSS recommended weight limits).

14. **Faceted Window Installations**

The offset drive permits up to a 12-degree (6°+6°) angle between any two shades with a single operator. By special order only, up to six degrees each side maximum. Contact MechoShade Systems, Inc. for details.

15. Optional SnapLoc® Fascia SnapLoc® fascia shall be provided for standard and extended height brackets and center support brackets. Each bracket assembly permits the fascia to extend past the brackets, creating wall-to-wall fascia, with the brackets mounted inboard from the end of the fascia. SnapLoc fascia can be installed as a single unit over two or more shade band assemblies without exposed joints in lengths up to 15 ft. (457cm). SnapLoc fascia snaps on to the brackets without the use of glue, magnetic strips or any exposed fastening.

The fascia is made of extruded aluminum (hardness/alloy 6063T5) with an average thickness of .062 in. (1.6mm). The fascia is finished in PPG Duracon™ baked enamel in six standard colors plus clear aluminum.

16. **Offset-Chain, No-Notch Fascia**

The operating chain drops behind the return edge of the fascia without the necessity of notching or otherwise defacing the return leg of the fascia. The MechoShade® Wide, and Extended brackets accommodate fascia returns no less than 1-1/2 in. (38mm) (50%) from the front of the hardware fully concealing the roll and tube.

17. **Shade Mounting**

The SnapLoc® spline permits positive SnapLoc mounting and unmounting of the shade cloth from the tube without having to remove the hardware, the tube or brackets and without the use of two-sided tape, staples or other fasteners.

18. **Non-Binding Regressed End Plug**

The idle-end plug is fitted with a recess which prevents oversized tubes from

Continued 



MechoShade® Hardware Features and Specifications

being forced between brackets. This arrangement assures proper sizing and clearance between the tube and the brackets and minimizes light leaks.

19. End Brackets

Consist of 1/8 in. (3mm) thick sheet steel. Wall, jamb or ceiling mounted as required and permanently installed.

20. Center Support Brackets

For ceiling or wall mounted multibanded shades. Center support brackets shall accept continuous lengths of fascia, which will span two or more MechoShade bands. Minimum length 15 ft. (457cm).

21. Hembar Weights

Mill-finished aluminum bars in single lengths as appropriate for the size shade, concealed in a fabric hem pocket.

22. Optional Exposed Hembars

In painted and baked PPG finishes with key way for shades.

23. DualShade® System:

The patented DualShade system, by MechoShade Systems, Inc., for installing both a ThermoVeil® sun screen together with either a room darkening shade cloth or MirroFilm™ attached to the same roller tube by means of the SnapLoc spline. The shade cloth and film shall be separated by 1/2 in. (13mm) of insulating air space.

24. DoubleShades®

A master mounting bracket assembly for drive-end, idle-end and center supports to facilitate installation of two shades, front-to-back or top and bottom, with perfect alignment and minimum installation labor.

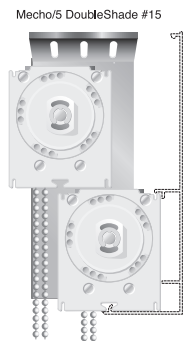

MECHO® SLIMLINE

SlimLine™ is available in the Mecho/3 design and shares all the features of the Mecho/5 except for the following:

1. Mounting Brackets

At 2-3/8 in. (60mm)W X 3-3/4 in. (95mm) H, the drive-end, idle-end and center supports become the smallest heavy-duty system available.

2. Variable Adjustment

Adjustments can be made in the dynamic mode (free-falling adjustment) or in the static mode (infinite-stop adjustment).

3. Braking

A linear disc brake, as opposed to a flat-steel backing plate, consists of a compression spring with two friction-absorbing nylon washers on a 1/4 in. (6mm) steel shaft. This design provides continuous uniform compensating brake pressure on the one-piece sprocket-brake drive component.



The compression spring also acts as a vibration absorber.

3.1. Non-Slip Disc-Brake Adjustment

A shake-proof steel and nylon vibration resistant locking nut is employed to maintain the desired braking friction. Once the desired brake force is applied, the adjustment nut will not require readjustment when slippage of the adjustment nut from vibration and weakening of the braking surfaces occur. The concealed brake-tension adjustment is not accessible to unauthorized personnel.

4. Braking Surface

The linear disc-brake system utilizes a minimum of 2.89 sq. in. of braking surface.

12. Narrow-Edge Clearances

Drive-end: 11/16 in. (17mm), idle-end: 1/2 in. (13mm), and center support: 5/16 in. (8mm).

DoubleShade® brackets have all the same features of the standard Mecho/5 bracket, plus allow both sun screen and blackout shades on a single bracket.

DoubleShade's compact size allow two shades to fit in a smaller room projection than two individually installed shades on the same window.

25. Warranty

Failure of any part or component shall be replaced at no charge, subject to warranty conditions. The drive chain is a fail safe component that is designed to break in two at 60-90 lbs.

(27-41 kg) of shock and is not covered by the warranty. The chain may be quickly repaired or spliced on site by maintenance personnel in minutes. (Contact MechoShade Systems for warranty terms and conditions.)

MechoShade Systems, Inc.
42-03 35th Street, Long Island City, NY 11101
Telephone: 718-729-2020
Fax: 718-729-2941 / 800-899-8081

E-mail: info@mechoshade.com
Internet Web Site: <http://www.mechoshade.com>

2.21
MS2200-01/01/08





The Suburban™/2 was developed in response to the need for a well designed, high quality, moderately priced roller shade for commercial or residential shades. The Suburban/2's clean lines, care-free maintenance and high quality components are backed by a Ten-Year Limited Warranty that makes it a great value for a limited budgets and/or a tight space requiring a small profile.

The Suburban/2 features:

- Energy-conserving ShadeCloths. Suburban/2 offers the most extensive line of sun screens and blackout shade cloths in the industry. ThermoVeil® and EuroVeil® Shade-Cloths provide visually transparent shading, with excellent glare control, energy savings and reduction in solar gain. Densities range from 0 to 15% openness factor, translucent to highly transparent. *See Section 5 – ShadeCloth for details.*
- The Suburban/2 is a manual shade comprised of an overrunning clutch braking system that requires no adjustment, and is operated by a nickel plated steel chain.
- Universal end caps allow for wall, ceiling or jamb mounting and are made of high impact ABS for a high quality finish.
- When fully exposed Suburban/2 has a clean finished look with the

convenience and flexibility of individual components.

- The Suburban/2 drive and idle mechanisms utilize high quality molded operating components of Delrin® and Delrin® with Teflon®.
- SnapLoc™ Mini Spline allows for easy removal of the shade cloth without removing the roller tube from the brackets.
- SnapLoc extruded aluminum Roller Tubes are available in 1-1/4" (32mm) diameter or 1-3/8" (35mm) diameter sizes. SnapLoc roller tubes include a mounting channel for the SnapLoc Mini Spline.
- #10 nickel plated steel bead chain with qualified spacing assuring smooth and precise operation at 45 lb. (20kg) minimum breaking strength.
- Chain stop beads control the upper and lower limits of the shade.
- Child-Safe Chain Retainer with SnapLoc base (optional) required for residential applications.
- Drive-end plugs with steel shaft pins.
- Idle-end plugs with steel shaft pins.
- Square continuous SnapLoc fascia conceals the hardware for a clean built-in look (optional).
- Bracket design allows for a continuous fascia to be extended wall to wall and/or over several shades.
- Flat aluminum hembar is concealed within the shadeband or available as an optional exposed light seal hembar.

1. Universal Mounting Bracket for Continuous Fascia Left-Hand Drive Ceiling Mount or Right-Hand Drive Wall Mount
- 1-A. Universal Mounting Bracket for Flush Mount Fascia Left-Hand Drive Ceiling Mount or Right-Hand Drive Wall Mount
2. Idle-End Housing
3. Idle-End Tube Plug
4. SnapLoc Tube
5. SnapLoc Spline Mounting Channel
6. Drive-End Tube Plug
7. Snaploc Mini Spline
8. Hembar (standard cloth covered)
- 8-A. Exposed Hembar (optional)
9. Drive-End Housing Assembly
10. Universal Mounting Bracket for Continuous Fascia Right-Hand Drive Ceiling Mount or Left-Hand Drive Wall Mount
- 10-A. Universal Mounting Bracket for Continuous Fascia Right-Hand Drive Ceiling Mount or Left-Hand Drive Wall Mount
11. Upper and Lower Bead Chain Stops
12. Drive Chain (nickel plated bead chain)
13. Chain Retainer
14. Bead Chain Connector
15. Optional SnapLoc Fascia

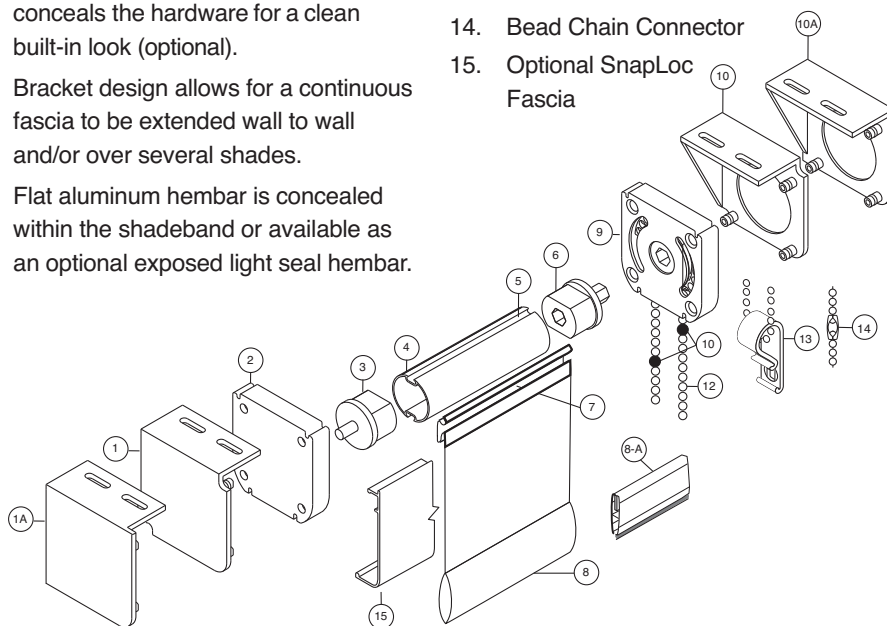

MechoShade Systems, Inc.
42-03 35th Street, Long Island City, NY 11101
Telephone: 718-729-2020
Fax: 718-729-2941 / 800-899-8081

E-mail: info@mechoshade.com
Internet Web Site: <http://www.mechoshade.com>

2.22
MS2200-01/01/08



ThermoVeil® 0900, 1000, 1300, 1800, 2100, 3000, 6000 & Equinox

| | | 1.204" TUBE | | | | | 1-3/8" Tube | | |
|-----------------|-----------------------------|-------------------------|-----|-----|-----|-----|-------------|-----|--|
| WIDTH | | 24" | 36" | 48" | 60" | 72" | 84" | 96" | |
| HEIGHTS | Non-Railroded Roller Shades | | | | | | | | |
| | 24" | ● | ● | ● | ● | ● | ● | ● | |
| | 36" | ● | ● | ● | ● | ● | ● | ● | |
| | 48" | ● | ● | ● | ● | ● | ● | ● | |
| | 60" | ● | ● | ● | ● | ● | ● | ● | |
| | 72" | ● | ● | ● | ● | ● | ● | ● | |
| | 84" | ● | ● | ● | ● | ● | ● | ● | |
| | 96" | ● | ● | ● | ● | ● | ● | ● | |
| UP TO | 108" | X | | | | | | | |
| | 120" | X | | | | | | | |
| | | Railroded Roller Shades | | | | | | | |
| | 54" | ● | ● | ● | ● | ● | ● | ● | |
| | 87" | ● | ● | ● | ● | ● | X | | |
| Optional Fascia | | | | | | | | | |
| F | Fascia | ● | ● | ● | ● | ● | ● | ● | |

EuroVeil® 5300 Series

| | | 1.204" TUBE | | | | | 1-3/8" Tube | | |
|-----------------|-----------------------------|-------------------------|-----|-----|-----|-----|-------------|-----|--|
| WIDTH | | 24" | 36" | 48" | 60" | 72" | 84" | 96" | |
| HEIGHTS | Non-Railroded Roller Shades | | | | | | | | |
| | 24" | ● | ● | ● | ● | ● | ● | ● | |
| | 36" | ● | ● | ● | ● | ● | ● | ● | |
| | 48" | ● | ● | ● | ● | ● | ● | ● | |
| | 60" | ● | ● | ● | ● | ● | ● | ● | |
| | 72" | ● | ● | ● | ● | ● | ● | ● | |
| | 84" | ● | ● | ● | ● | ● | ● | ● | |
| | 96" | ● | ● | ● | ● | ● | ● | ● | |
| UP TO | 108" | ● | ● | ● | ● | ● | ● | ● | |
| | 120" | ● | ● | ● | ● | ● | X | | |
| | | Railroded Roller Shades | | | | | | | |
| | 54" | ● | ● | ● | ● | ● | ● | ● | |
| | 87" | ● | ● | ● | ● | ● | X | | |
| Optional Fascia | | | | | | | | | |
| F | Fascia | ● | ● | ● | ● | ● | ● | ● | |

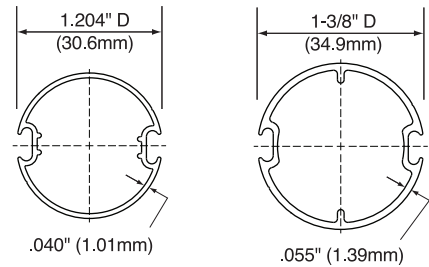

SnapLoc® Tube

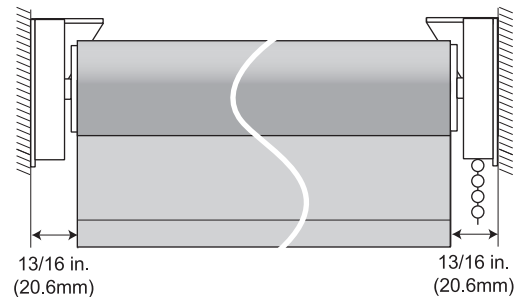
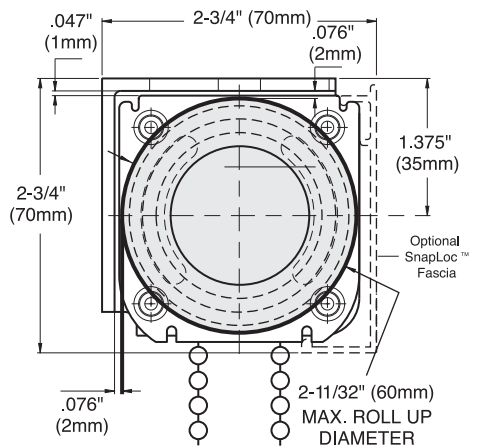

UNIVERSAL MOUNTING – For Continous Ends Only

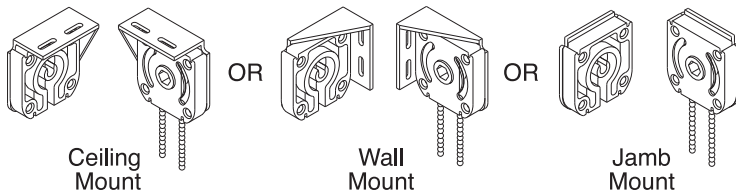

MechoShade Systems, Inc.
 42-03 35th Street, Long Island City, NY 11101
 Telephone: 718-729-2020
 Fax: 718-729-2941 / 800-899-8081

E-mail: info@mechoshade.com
 Internet Web Site: <http://www.mechoshade.com>

2.23
 MS2200 - 01/01/08



Batten and Seam Specifications

Battens vs. Seams: MechoShade Systems, Inc. is one of the only, if not the only, shade manufacturer to use a batten joint vs. a seam joint. This type of construction costs more, but is highly effective in ensuring that certain types of shade bands hang and track straight. See below for an illustration of the Batten vs. Seam joint.

Woven ScreenCloth: All woven ScreenCloth, regardless if their core yarns are polyester or fiberglass, will stretch under their hanging weight due to "Woven Fabric Mechanical Extensibility" or "The Hour Glass Effect". In order to assure the proper tracking and rolling of the shadeband, and avoid the "Hour Glass Effect", battens are included by MechoShade as a standard detail when the width-to-height (W:H) ratio exceeds 1:4. Railroaded, multi-width shade bands will receive a 1-1/2" (38mm) batten joint. Battens may be specified for shade bands that otherwise do not need them to align with shade bands that do require battens, at additional cost. Battens will be positioned on the shade band, per the chart below, or at customer specified positions, subject to approval of MechoShade Systems, Inc., and may be at additional cost.

Standard Batten Placement for Non-Railroaded (Standard) MechoShades:

- Batten placement for non-railroaded shades shall be the minimum required to meet the 1:4 ratio of width to height.
- Battens shall be equally spaced within the shadeband opening height. For example one batten at the mid point, or two battens at 1/3 points, or three battens at 1/4 points.
- Batten placement for blackout shades with side channels shall not exceed 4'-0" (122cm) o.c. and must be specified.

| Standard Batten Placement for Railroaded (RR) MechoShades* | | | | |
|--|-----------------|-----------------|-----------------|------------------|
| Roll Widths | 63" (160cm) RR* | 72" (183cm) RR* | 96" (244cm) RR* | 126" (366cm) RR* |
| Requires 1 width Railroaded* no seam | | | | |
| Requires 1-1/2 widths Railroaded*, +1 seam | | | | |
| Requires 2 widths Railroaded*, +1 seam | | | | |
| Requires 2-1/2 widths Railroaded*, +2 seam | | | | |
| Requires 3 widths Railroaded*, +2 seams | | | | |

* All shades are measured from the bottom of the shade up to the center of the Batten joint. Railroad (RR) Shadecloth is turned width to height. All heights shown above are Opening Heights only and are based on a 1-1/2" diameter tube. Opening Heights do not include wrap. Cut panel sizes, including wrap, hem-pocket and additional fabric for sealing battens and seams, are added to the opening height dimension

Width-to-Height (W:H) Ratio Guidelines and Edge-Clearance Specifications (fabric used normally or railroaded)





- **Shadebands up to 1:3 W:H ratio**, require the standard edge-clearance deduction except for 30" (76cm) wide shadebands.
- **1:3 to 1:4 W:H ratios**, increase the hardware edge-clearance 1/16" (1.6mm) each side to 1/8" (3.2mm) additional deduction.
- **1:4 to 1:5 W:H ratios**, increase the hardware edge-clearance 1/8" (3.2mm) each side to 1/4" (6.4mm) additional deduction. Battens or optional guide cables are required.
- **1:5 to 1:6 W:H ratios**, increase the hardware edge-clearance 1/4" (6.4mm) each side to 1/2" (12.8mm) additional deduction. Battens or optional guide cables are required.
- **Over 1:6 W:H ratios**, increase the hardware edge-clearance 5/16" (8mm) each side to 5/8" (16mm) additional deduction. Battens & guide cables are required.
- **Railroaded multi-width shades** with horizontal joints shall have seam joints.
- **Environmental conditions may require** additional use of guide cables and/or battens and increased edge clearance.

MechoShade Systems, Inc.
 42-03 35th Street, Long Island City, NY 11101
 Telephone: 718-729-2020
 Fax: 718-729-2941 / 800-899-8081

E-mail: info@mechoshade.com
 Internet Web Site: www.mechoshade.com

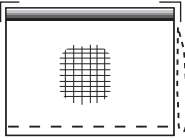
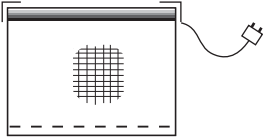
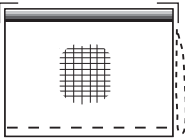
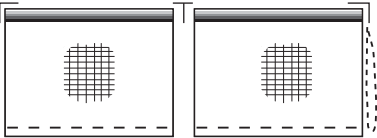
604/2
 REVISION
2.24
 MS2200-01/01/08

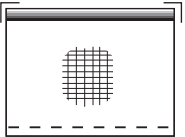
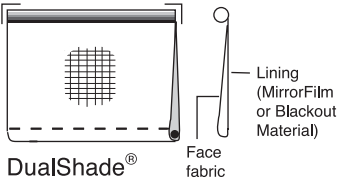
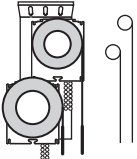
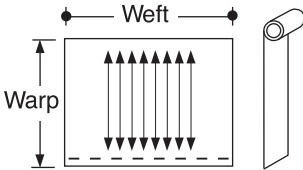
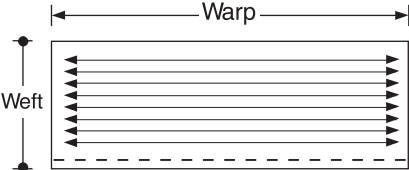
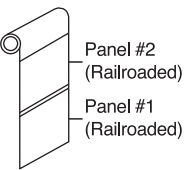
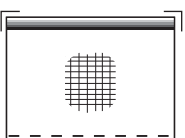
ShadeWords

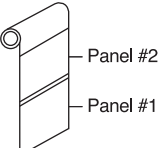
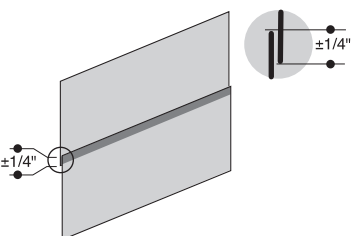
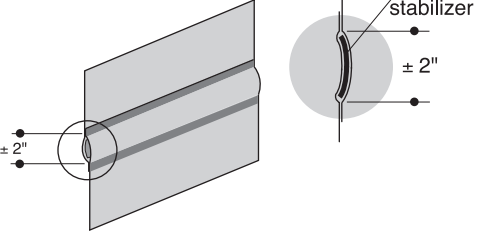
| Item | Definition |
|--|---|
| MechoShade® ElectroShade® |   <p>MechoShade® ElectroShade®</p> |
| SingleBand™ MultiBand™ Regular- & Reverse-Roll |     <p>SingleBand MultiBand™ (2 or more shadebands on one operator MechoShades or ElectroShades)</p> <p>Regular Roll (unwinds towards glass) Reverse Roll (unwinds away from glass)</p> |
| SingleShade™ DualShade® DoubleShade™ |    <p>SingleShade™ (Standard) DualShade® DoubleShade™ (2 on 1 bracket)</p> |
| Non-Railroaded ShadeCloth (NRR) (Standard) Railroaded ShadeCloth (RR) (Landscape) |    <p>Non-Railroaded ShadeCloth (ShadeCloth used normally) Railroaded ShadeCloth (ShadeCloth used width for height)</p> |
| SingleWidth™ MultiWidth™ |    <p>SingleWidth™ (No seams) MultiWidth™ (A shadeband with 2 or more widths joined with a joint batten)</p> <p>(Railroaded or Non-Railroaded)</p> |
| Seam joint (Special) Batten joint (Standard) |   <p>Seam joint (Special) Batten joint (Standard)</p> |

MechoShade Systems, Inc.
42-03 35th Street, Long Island City, NY 11101
Telephone: 718-729-2020
Fax: 718-729-2941 / 800-899-8081

E-mail: info@mechoshade.com
Internet Web Site: <http://www.mechoshade.com>

2.25
MS2200-01/01/08

